

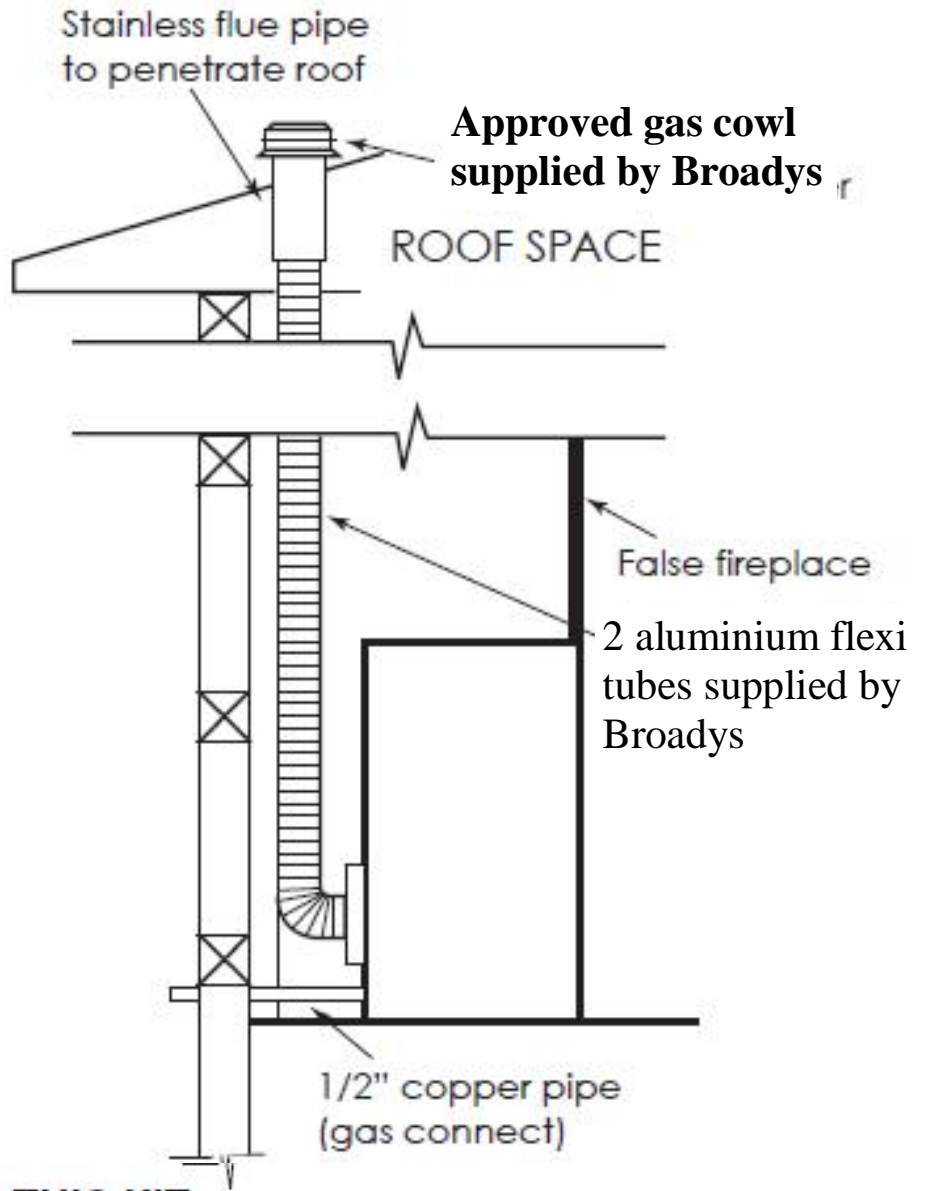

Installation of this gas heating appliance must be to NZS 5261

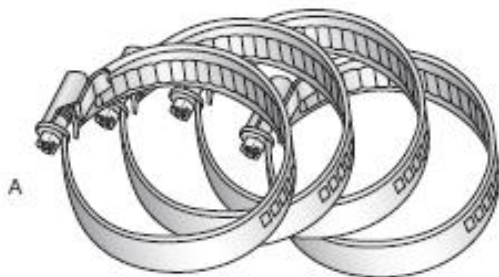

WHAT'S IN THIS KIT



- A. 4 Flue clamps
- B. 1 Cowl
- C. Gas fume exhaust
- D. Air intake
- E. Stainless steel flue pipe

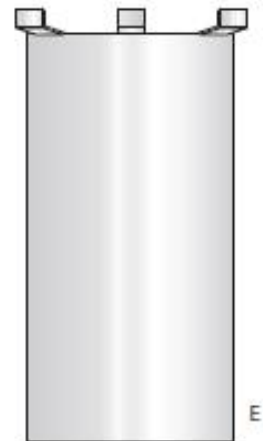
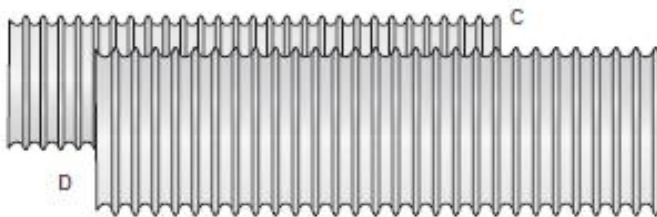
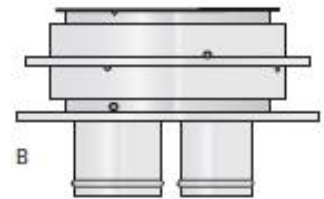

WWW.BROADYS.CO.NZ

Flue Installation should be read in conjunction with Enviro Quick Step Installation Sheet or full installation manual provided with the fireplace.

step 1

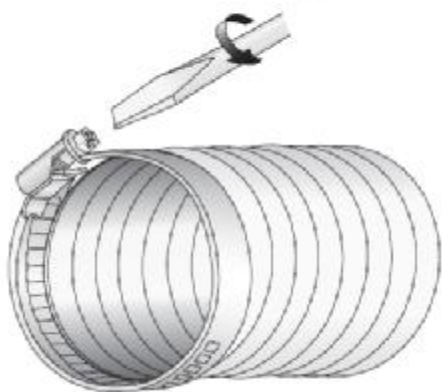

Using a flat head screw driver, unscrew the flue clamp as necessary until it fits over the end of each of the flexi flue pipes

step 2



Stretch out the end of each flexible flue pipe. Slide the two flexi flue pipes over the corresponding pipes at the rear of the firebox

step 3

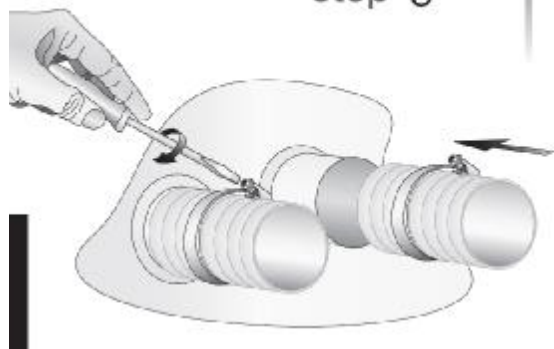

Tighten flue clamps to secure flues to the firebox

step 4

Stretch out the flue as required up to 4.5m or cut to size as required. Ensure there are no tears or holes in the flues

<p>DO...</p>	<p>Use 3 bends only ✓</p> <p>Our flexible flue has the ability to bend 3 times between the heating unit and the cowl. This includes the bend straight out of the heater if you're fluing through the ceiling or</p>
<p>DO...</p>	<p>Make the flue pipe go over the bearers and joists ✓</p> <p>You may bend the flue over joists and bearers. It is recommended that a 20mm clearance be maintained between the smaller gas exhaust flue and combustible materials</p>
<p>NEVER DO...</p>	<p>Flueing where the pipe has a spot Lower than the rest ✗</p> <p>Never allow a low spot in the flue. Installing the flue with a dip or "goose neck" can result in reduced efficiency or even prevent the fire from working.</p>

step 5



Feed two flexi flues through the 1200mm stainless steel flue pipe

N.B Remember not to have a dip anywhere in the flue. It is important that a 20mm clearance is maintained between the smaller extraction flue and combustible materials.

step 6

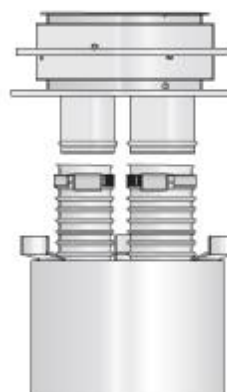

As in Step 1, unscrew the flue clamps until they fit over each of the flue pipes. Slide the two flue pipes over the corresponding pipes on the base of the cowl and tighten. Suitable roof flashing must be used to comply with E2 of the building code

WWW.BROADYS.CO.NZ

Flue Installation should be read in conjunction with Enviro Quick Step Installation Sheet or full installation manual provided with the fireplace.